

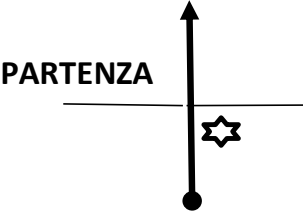



Settore	<b>Piacenza</b>	Distanza Km.	58,260
<b>1</b>		Tempo Imposto	1h 35' 00"
		<b>Soarza</b>	Media Km/h

Distanza			INFORMAZIONI	Distanza dal C.O.
Parziale	Totale			
<b>0,000</b>	0,000	1 PARTENZA 		58,260
<b>0,080</b>	0,080	2 	 statua girevole S. Antonino	58,180
<b>0,140</b>	0,220	3 	Via 24 Maggio	58,040
<b>0,550</b>	0,770	4 		57,490
<b>0,650</b>	1,420	5 		56,840
<b>0,310</b>	1,730	6 		56,530

Settore	<b>Piacenza</b>	Distanza Km.	58,260
<b>1</b>		Tempo Imposto	1h 35' 00"
	<b>Soarza</b>	Media Km/h	35,00

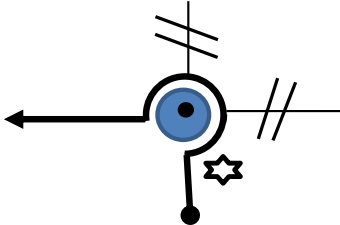
Distanza			INFORMAZIONI	Distanza dal C.O.
Parziale	Totale			
<b>1,410</b>	3,140	7 	<div style="border: 1px solid black; padding: 5px;"> <p>CREMONA</p> <p>PARMA</p> <p>Tangenziale Nord</p> </div>	55,120
<b>0,150</b>	3,290	8 	<div style="border: 1px solid black; padding: 5px;"> <p>bivio senza indicazioni per il sottopasso</p> </div> <p>!!!!!! ATTENZIONE</p>	54,970
<b>0,240</b>	3,530	9 	SOTTOPASSO	54,730
<b>0,360</b>	3,890	10 		54,370
<b>0,260</b>	4,150	11 	!!!!!! ATTENZIONE 2 dossi	54,110
<b>0,320</b>	4,470	12 		53,790

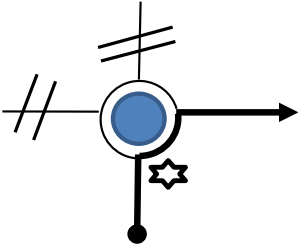
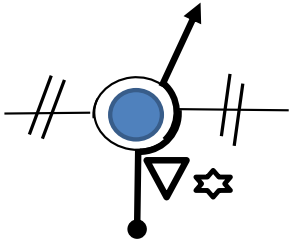
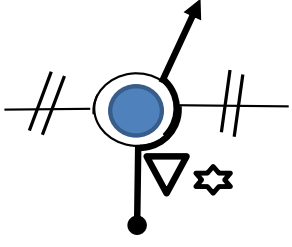
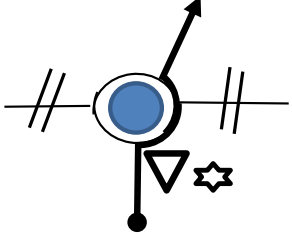
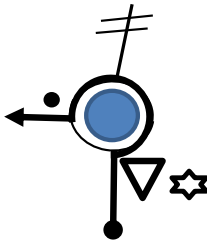
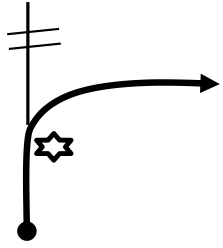
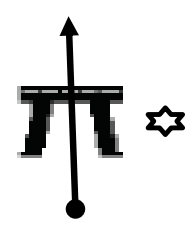
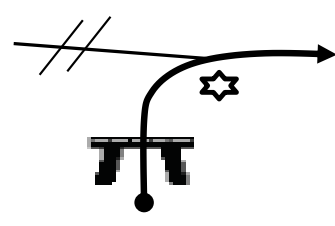
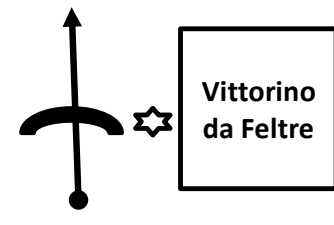
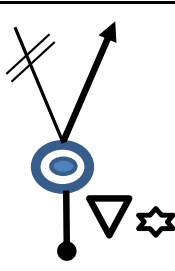
Settore	<b>Piacenza</b>	Distanza Km.	58,260
<b>1</b>		Tempo Imposto	1h 35' 00"
	<b>Soarza</b>	Media Km/h	35,00

Distanza			INFORMAZIONI	Distanza dal C.O.
Parziale	Totale			
<b>0,160</b>	4,630	13 		53,630
<b>0,400</b>	5,030	14 		53,230
<b>0,770</b>	5,800	15 	● specchio	52,460
<b>0,410</b>	6,210	16 	<b>ATTENZIONE !!!</b>	52,050
<b>0,260</b>	6,470	17 	Via Arda	51,790
<b>0,730</b>	7,200	18 	<b>!!!!!! ATTENZIONE</b> dosso	51,060

Settore	<b>Piacenza</b>	Distanza Km.	58,260
<b>1</b>		Tempo Imposto	1h 35' 00"
	<b>Soarza</b>	Media Km/h	35,00

Distanza			INFORMAZIONI	Distanza dal C.O.
Parziale	Totale			
<b>0,130</b>	7,330	19	!!!!!! ATTENZIONE dosso	50,930
<b>0,170</b>	7,500	20		50,760
<b>0,100</b>	7,600	21	MORTIZZA GERBIDO	50,660
<b>0,520</b>	8,120	22	<del>BONIFICA CIRTERNE</del>	50,140
<b>0,800</b>	8,920	23	GERBIDO MORTIZZA	49,340
<b>0,340</b>	9,260	24	GERBIDO	49,000

Settore	<b>Piacenza</b>	Distanza Km.	58,260
<b>1</b>		Tempo Imposto	1h 35' 00"
	<b>Soarza</b>	Media Km/h	35,00

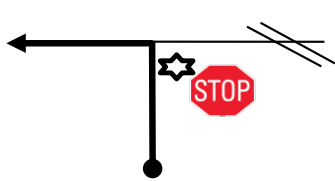
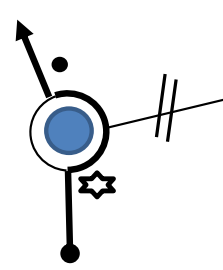
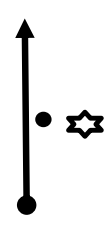
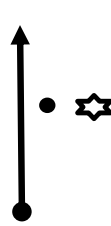
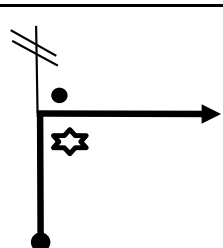
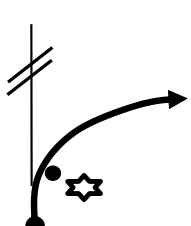
Distanza			INFORMAZIONI	Distanza dal C.O.
Parziale	Totale			
<b>0,220</b>	9,480	25 		<b>48,780</b>
<b>0,380</b>	9,860	26 	MORTIZZA	<b>48,400</b>
<b>1,600</b>	11,460	27 	BOSCO DEI SANTI	<b>46,800</b>
<b>0,590</b>	12,050	28 	MORTIZZA	<b>46,210</b>
<b>0,450</b>	12,500	29 	LAGO VERDE	<b>45,760</b>
<b>0,800</b>	13,300	30 	Strada Sparavera	<b>44,960</b>

Settore	<b>Piacenza</b>	Distanza Km.	58,260
<b>1</b>		Tempo Imposto	1h 35' 00"
		<b>Soarza</b>	Media Km/h

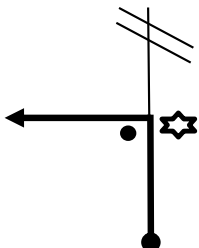
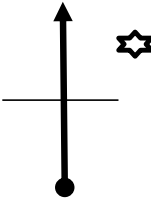
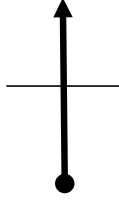
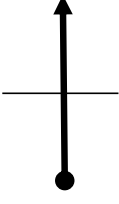
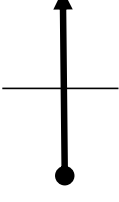
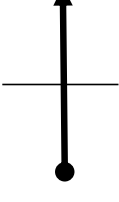
Distanza			INFORMAZIONI	Distanza dal C.O.
Parziale	Totale			
<b>3,000</b>	16,300	31 	Strada Gargatano  inizio sterrato	41,960
<b>0,200</b>	16,500	32 	INIZIO P.C. 1  metri 50	41,760
<b>0,050</b>	16,550	33 	FINE P.C. 1  INIZIO P.C. 2  metri 50	41,710
<b>0,050</b>	16,600	34 	FINE P.C. 2  INIZIO P.C. 3  metri 50	41,660
<b>0,050</b>	16,650	35 	FINE P.C. 3  INIZIO P.C. 4  metri 40	41,610
<b>0,040</b>	16,690	36 	FINE P.C. 4  INIZIO P.C. 5  metri 80	41,570

Settore	<b>Piacenza</b>	Distanza Km.	58,260
<b>1</b>		Tempo Imposto	1h 35' 00"
	<b>Soarza</b>	Media Km/h	35,00

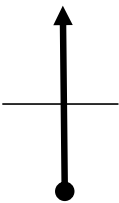
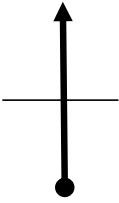
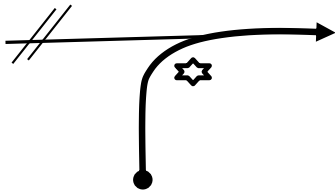
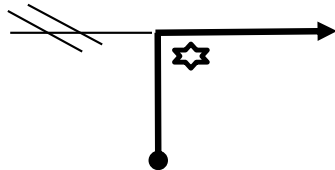
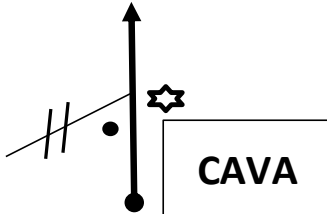
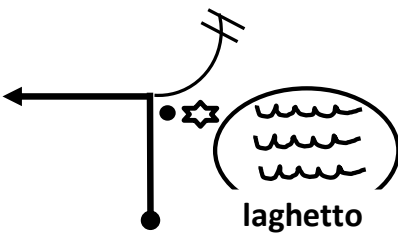
Distanza			INFORMAZIONI	Distanza dal C.O.
Parziale	Totale			
<b>0,080</b>	16,770	37 	<div style="border: 1px solid black; padding: 2px; display: inline-block;">FINE P.C. 5</div> <div style="border: 1px solid black; padding: 2px; display: inline-block;">INIZIO P.C. 6</div> <div style="border: 1px solid black; padding: 2px; display: inline-block;">metri 90</div>	41,490
<b>0,090</b>	16,860	38 	<div style="border: 1px solid black; padding: 2px; display: inline-block;">FINE P.C. 6</div>	41,400
<b>0,050</b>	16,910	39 	seguire a destra sullo sterrato	41,350
<b>0,500</b>	17,410	40 	ATTENZIONE PEDONI  fine sterrato	40,850
<b>2,130</b>	19,540	41 	<div style="border: 1px solid black; padding: 2px; display: inline-block;">Via Ghernardi</div> <div style="border: 1px solid black; padding: 2px; display: inline-block;"><del>Via Mussi</del></div>	38,720
<b>0,370</b>	19,910	42 	<div style="border: 1px solid black; padding: 2px; display: inline-block;">Via Ghernardi</div>	38,350

Settore	<b>Piacenza</b>	Distanza Km. 58,260
<b>1</b>		Tempo Imposto 1h 35' 00"
	<b>Soarza</b>	Media Km/h 35,00

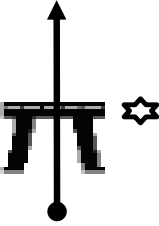
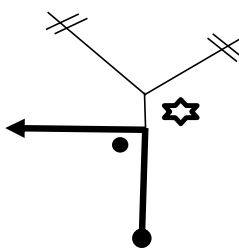
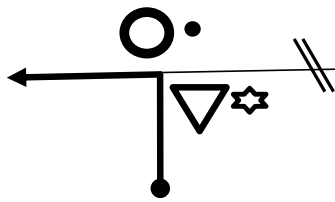
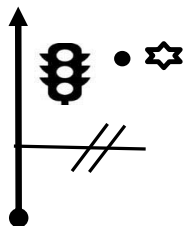
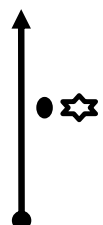
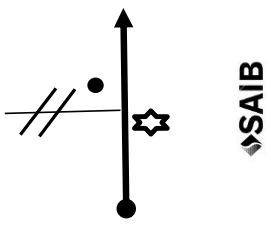



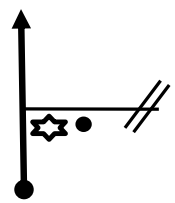
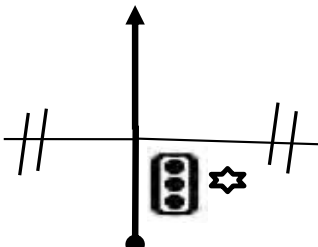
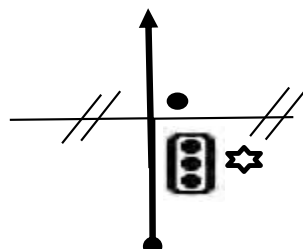
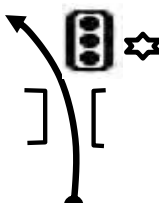
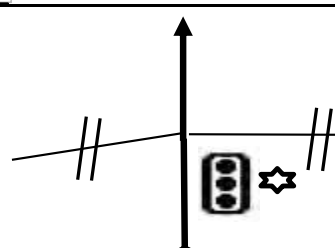
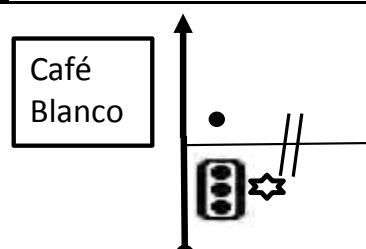

Distanza			INFORMAZIONI	Distanza dal C.O.
Parziale	Totale			
<b>0,200</b>	20,110	43 	<b>SOTTOPASSO</b>	<b>38,150</b>
<b>0,200</b>	20,310	44 	<b>Strada della Volpara</b>	<b>37,950</b>
<b>0,830</b>	21,140	45 	<b>SPECCHIO</b> <b>ATTENZIONE !!!</b>	<b>37,120</b>
<b>0,060</b>	21,200	46 	<b>SEMAFORO</b>	<b>37,060</b>
<b>0,450</b>	21,650	47 	<b>FOSSADELLO</b> <b>FUSADEL</b>	<b>36,610</b>
<b>1,470</b>	23,120	48 	<b>RONCAROLO</b>	<b>35,140</b>

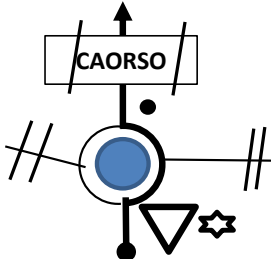

Settore	<b>Piacenza</b>	Distanza Km.	58,260
<b>1</b>		Tempo Imposto	1h 35' 00"
		<b>Soarza</b>	Media Km/h

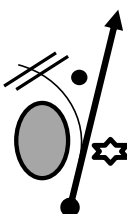
Distanza			INFORMAZIONI	Distanza dal C.O.
Parziale	Totale			
<b>3,650</b>	26,770	49 	<del>MURADOLO</del> <del>PONTENURE</del>	<b>31,490</b>
<b>0,360</b>	27,130	50 		<b>31,130</b>
<b>0,280</b>	27,410	51 	<del>CHIAVENNA</del>	<b>30,850</b>
<b>0,160</b>	27,570	52 		<b>30,690</b>
<b>0,110</b>	27,680	53 		<b>30,580</b>
<b>0,280</b>	27,960	54 	<del>POLIGNANO</del>	<b>30,300</b>

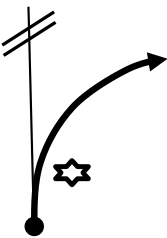
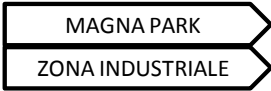
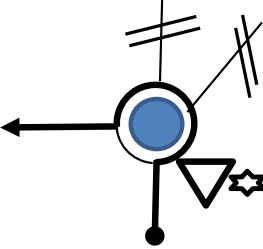
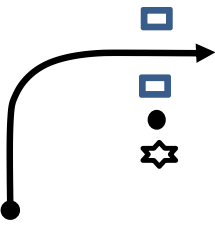
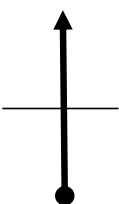
Settore	<b>Piacenza</b>	Distanza Km.	58,260
<b>1</b>		Tempo Imposto	1h 35' 00"
		<b>Soarza</b>	Media Km/h

Distanza			INFORMAZIONI	Distanza dal C.O.
Parziale	Totale			
<b>1,270</b>	29,230	55 		29,030
<b>0,740</b>	29,970	56 		28,290
<b>0,710</b>	30,680	57 		27,580
<b>0,400</b>	31,080	58 		27,180
<b>0,150</b>	31,230	59 	<b>arco in tubi giallo</b> <b>Ingresso prove</b>	27,030
<b>0,050</b>	31,280	60 	 	26,980

Settore	<b>Piacenza</b>	Distanza Km. 58,260
<b>1</b>		Tempo Imposto 1h 35' 00"
	<b>Soarza</b>	Media Km/h 35,00

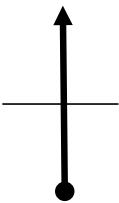
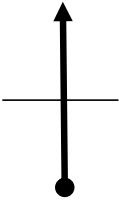
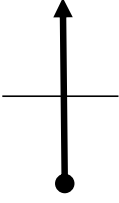
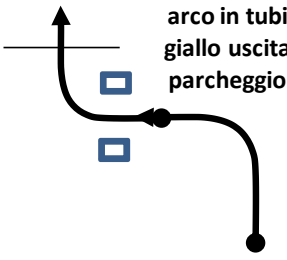
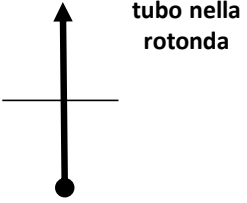
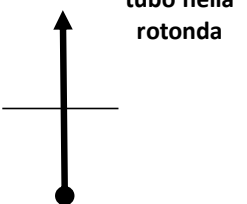
Distanza			INFORMAZIONI	Distanza dal C.O.
Parziale	Totale			
<b>0,050</b>	31,330	61 	<div style="border: 1px solid black; padding: 2px; margin-bottom: 5px;">FINE P.C. 7</div> <div style="border: 1px solid black; padding: 2px; margin-bottom: 5px;">START P.C. 8</div> <div style="border: 1px solid black; padding: 2px; margin-bottom: 5px;">metri 90</div>	26,930
<b>0,090</b>	31,420	62 	<div style="border: 1px solid black; padding: 2px; margin-bottom: 5px;">FINE P.C. 8</div> <div style="border: 1px solid black; padding: 2px; margin-bottom: 5px;">START P.C. 9</div> <div style="border: 1px solid black; padding: 2px; margin-bottom: 5px;">metri 60</div>	26,840
<b>0,060</b>	31,480	63 	<div style="border: 1px solid black; padding: 2px; margin-bottom: 5px;">FINE P.C. 9</div> <div style="border: 1px solid black; padding: 2px; margin-bottom: 5px;">START P.C. 10</div> <div style="border: 1px solid black; padding: 2px; margin-bottom: 5px;">metri 80</div>	26,780
<b>0,080</b>	31,560	64 	<div style="border: 1px solid black; padding: 2px; margin-bottom: 5px;">FINE P.C. 10</div> <div style="border: 1px solid black; padding: 2px; margin-bottom: 5px;">START P.C. 11</div> <div style="border: 1px solid black; padding: 2px; margin-bottom: 5px;">metri 50</div>	26,700
<b>0,050</b>	31,610	65 	<div style="border: 1px solid black; padding: 2px; margin-bottom: 5px;">FINE P.C. 11</div> <div style="border: 1px solid black; padding: 2px; margin-bottom: 5px;">START P.C. 12</div> <div style="border: 1px solid black; padding: 2px; margin-bottom: 5px;">metri 70</div>	26,650
<b>0,070</b>	31,680	66 	<div style="border: 1px solid black; padding: 2px; margin-bottom: 5px;">FINE P.C. 12</div> <div style="border: 1px solid black; padding: 2px; margin-bottom: 5px;">START P.C. 13</div> <div style="border: 1px solid black; padding: 2px; margin-bottom: 5px;">metri 70</div>	26,580

Settore	<b>Piacenza</b>	Distanza Km.	58,260
<b>1</b>		Tempo Imposto	1h 35' 00"
	<b>Soarza</b>	Media Km/h	35,00

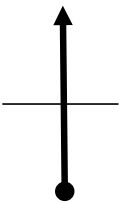
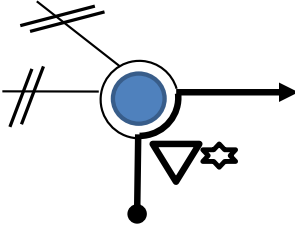
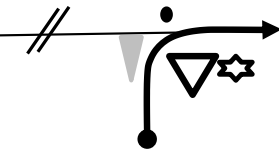
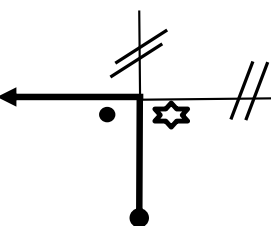
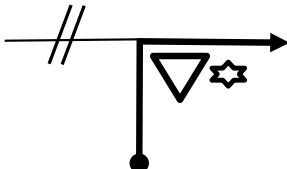
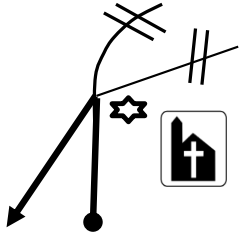
Distanza			INFORMAZIONI	Distanza dal C.O.
Parziale	Totale			
<b>0,070</b>	31,750	67 	<b>FINE P.C. 13</b>	26,510
<b>0,360</b>	32,110	68 		26,150
<b>0,420</b>	32,530	69 	<b>A1</b>	25,730
<b>0,460</b>	32,990	70 	<b>SAN NAZZARO</b>  <b>rallentare attraversamento abitato !!!</b>	25,270
<b>0,530</b>	33,520	71 		24,740
<b>0,100</b>	33,620	72 		24,640

Settore	<b>Piacenza</b>	Distanza Km.	58,260
<b>1</b>		Tempo Imposto	1h 35' 00"
		<b>Soarza</b>	Media Km/h

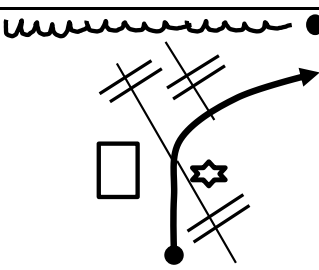
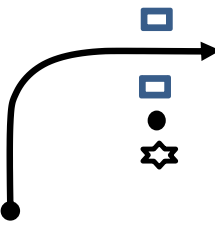
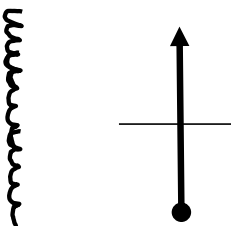
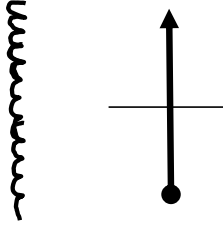
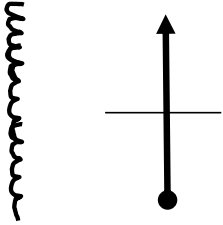
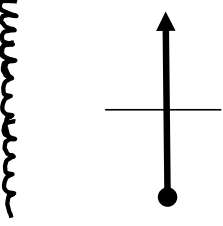
Distanza			INFORMAZIONI	Distanza dal C.O.
Parziale	Totale			
<b>0,100</b>	33,720	73 	● <b>Fiume PO</b>	24,540
<b>0,150</b>	33,870	74 	● <b>SBARRA</b>  !!! ATTENZIONE !!! PASSAGGIO PEDONI	24,390
<b>0,150</b>	34,020	75 	<b>START PC 14</b>  metri 50	24,240
<b>0,050</b>	34,070	76 	<b>FINE P.C. 14</b> <b>START P.C. 15</b>  metri 50	24,190
<b>0,050</b>	34,120	77 	<b>FINE P.C. 15</b> <b>START P.C. 16</b>  metri 80	24,140
<b>0,080</b>	34,200	78 	<b>FINE P.C. 16</b> <b>START P.C. 17</b>  metri 70	24,060

Settore	<b>Piacenza</b>	Distanza Km. 58,260
<b>1</b>		Tempo Imposto 1h 35' 00"
		<b>Soarza</b>

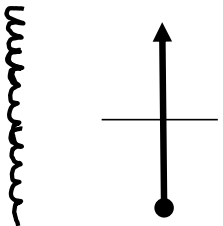
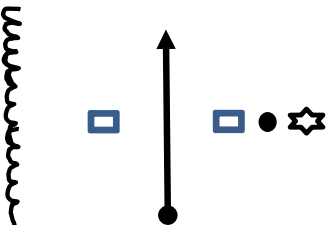
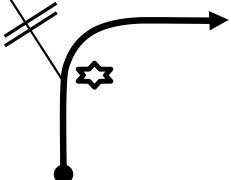
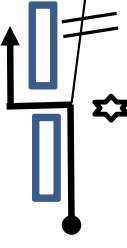
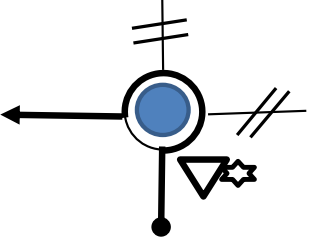
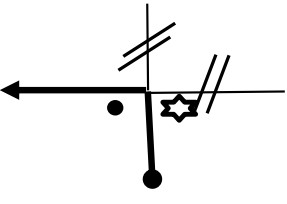
Distanza			INFORMAZIONI	Distanza dal C.O.
Parziale	Totale			
<b>0,070</b>	34,270	78 	<b>FINE P.C. 17</b>	23,990
<b>0,290</b>	34,560	79 	<b>!!!!!!! SBARRA</b>	23,700
<b>0,150</b>	34,710	80 		23,550
<b>0,130</b>	34,840	81 	<b>!!!!!!! ENTRARE NELL'APERTURA DEL GUARD RAIL</b>	23,420
<b>0,100</b>	34,940	82 	<b>PIACENZA</b> <b>MILANO</b>	23,320
<b>0,240</b>	35,180	83 	<b>Via Bosco Biliemme</b> <b>!!!!!!!!!!!</b>	23,080



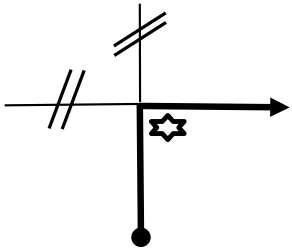
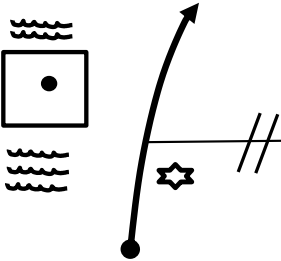
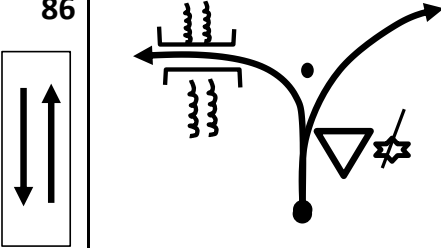
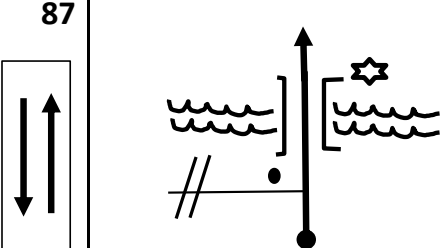
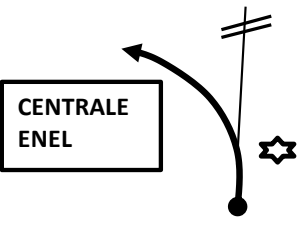
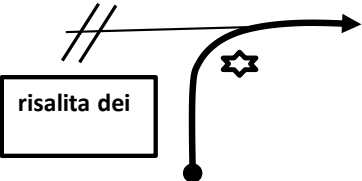

Settore	<b>Piacenza</b>	Distanza Km.	58,260
<b>1</b>		Tempo Imposto	1h 35' 00"
	<b>Soarza</b>	Media Km/h	35,00

Distanza			INFORMAZIONI	Distanza dal C.O.
Parziale	Totale			
<b>0,120</b>	35,300	84 		22,960
<b>1,140</b>	36,440	85 	<b>Chiusa sul PO</b>	21,820
<b>0,370</b>	36,810	86 	<b>ISOLA SERAFINII</b> <b>TUTTE LE DIREZIONI</b>	21,450
<b>0,200</b>	37,010	87 	<b>ISOLA SERAFINII</b>	21,250
<b>0,220</b>	37,230	88 	<b>dopo il ponte subito a sinistra - alla sbarra ignorare divieto di accesso</b>	21,030
<b>0,500</b>	37,730	88 		20,530

Settore		Piacenza		Distanza Km. 58,260	
1				Tempo Imposto 1h 35' 00"	
		Soarza		Media Km/h 35,00	
Distanza				INFORMAZIONI	
Parziale	Totale				Distanza dal C.O.
0,200	37,930	89			20,330
0,270	38,200	88			20,060
0,220	38,420	89			19,840
0,460	38,880	89			19,380
0,480	39,360	90			18,900
0,260	39,620	91			18,640

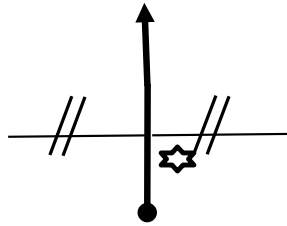
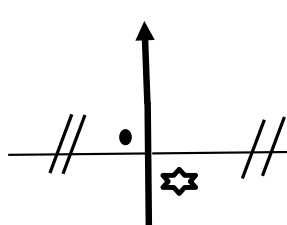

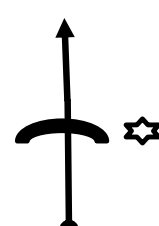
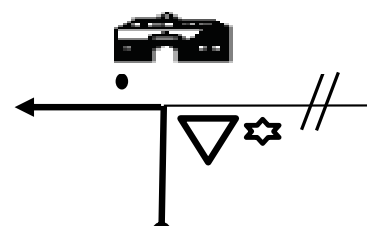
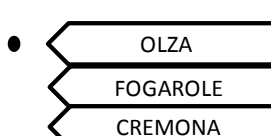
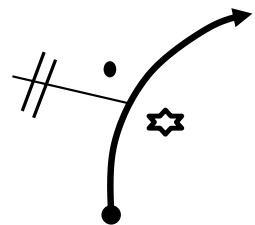

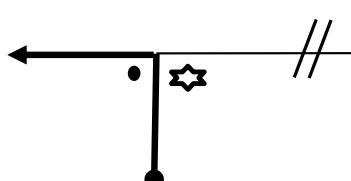
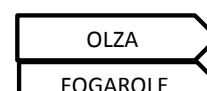
Settore	<b>Piacenza</b>	Distanza Km.	58,260
<b>1</b>		Tempo Imposto	1h 35' 00"
		<b>Soarza</b>	Media Km/h

Distanza			INFORMAZIONI	Distanza dal C.O.
Parziale	Totale			
<b>0,160</b>	39,780	92 		<b>18,480</b>
<b>0,140</b>	39,920	93 		<b>18,340</b>
<b>0,310</b>	40,230	94 		<b>18,030</b>
<b>0,130</b>	40,360	95 		<b>17,900</b>
<b>0,110</b>	40,470	96 		<b>17,790</b>
<b>0,240</b>	40,710	96 		<b>17,550</b>

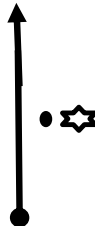
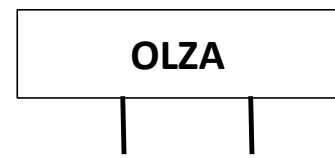
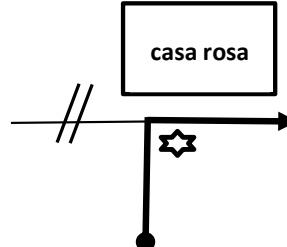
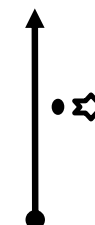
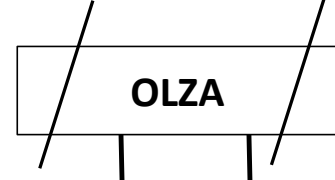
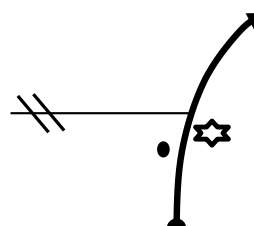
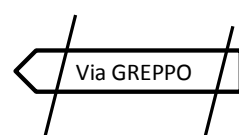
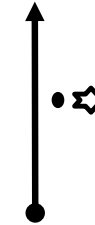
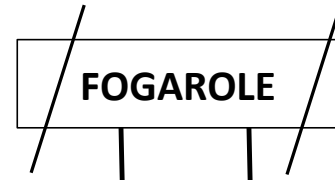
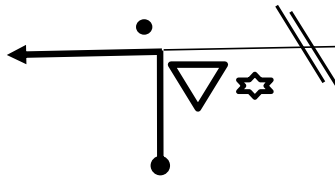
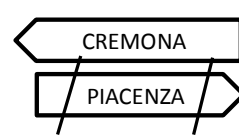
Settore	<b>Piacenza</b>	Distanza Km.	58,260
<b>1</b>		Tempo Imposto	1h 35' 00"
	<b>Soarza</b>	Media Km/h	35,00

Distanza			INFORMAZIONI	Distanza dal C.O.
Parziale	Totale			
<b>2,220</b>	42,930	97 		15,330
<b>0,560</b>	43,490	98 		14,770
<b>0,480</b>	43,970	99 		14,290
<b>0,480</b>	44,450	100 		13,810
<b>0,550</b>	45,000	101 		13,260
<b>1,220</b>	46,220	102 		12,040

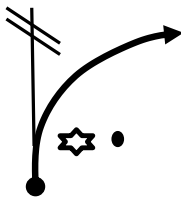
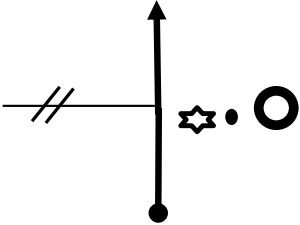
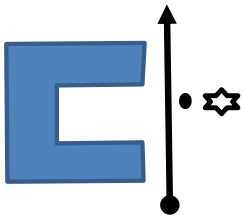

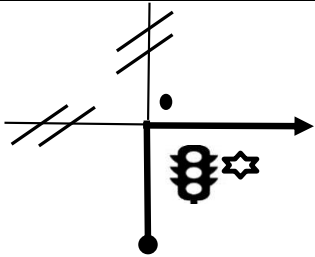
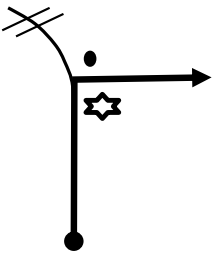
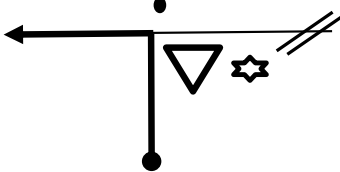

Settore	<b>Piacenza</b>	Distanza Km.	58,260
<b>1</b>		Tempo Imposto	1h 35' 00"
		<b>Soarza</b>	Media Km/h

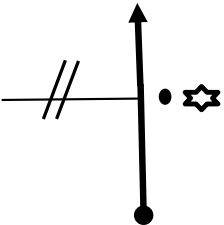
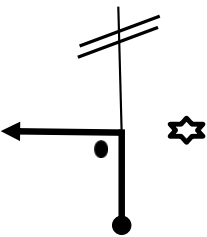
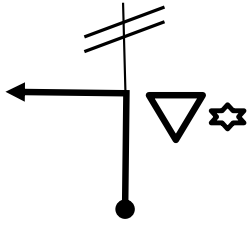
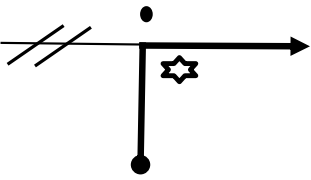
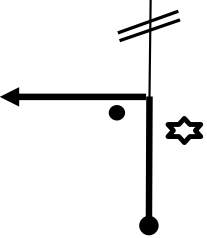
Distanza			INFORMAZIONI	Distanza dal C.O.
Parziale	Totale			
<b>0,890</b>	47,110	103 	CASTELVETRO	11,150
<b>0,950</b>	48,060	104 	SPECCHIO attenzione 3 DOSSI	10,200
<b>0,380</b>	48,440	105 	COMUNE DI CASTELVETRO PIACENTINO controllo a timbro 	9,820
<b>0,160</b>	48,600	106 	CREMONA VILLANOVA S.A. AUTOSTRADA	9,660
<b>0,240</b>	48,840	107 	Via Signorina Pierina Belli	9,420
<b>0,140</b>	48,980	108 	Via Pomello	9,280



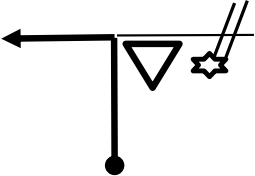
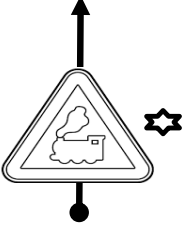
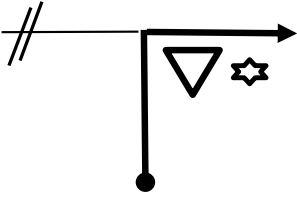
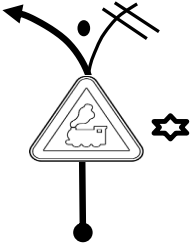

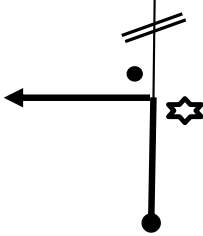
Settore	<b>Piacenza</b>	Distanza Km. 58,260
<b>1</b>		Tempo Imposto 1h 35' 00"
	<b>Soarza</b>	Media Km/h 35,00

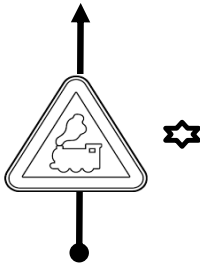
Distanza			INFORMAZIONI	Distanza dal C.O.
Parziale	Totale			
<b>1,020</b>	50,000	109 	<b>PASSAGGIO A LIVELLO ATTENZIONE: DOSSO</b>	<b>8,260</b>
<b>0,110</b>	50,110	110 	<b>Via Pomello</b> <b>Via Oppiazzzi</b>	<b>8,150</b>
<b>0,340</b>	50,450	111 	<b>SAN GIULIANO</b>	<b>7,810</b>
<b>2,020</b>	52,470	112 		<b>5,790</b>
<b>1,660</b>	54,130	113 	<b>Via Pavesa</b> <b>SAN GIULIANO</b>	<b>4,130</b>
<b>0,110</b>	54,240	114 	<b>VILLANOVA</b>	<b>4,020</b>

Settore	<b>Piacenza</b>	Distanza Km.	58,260
<b>1</b>		Tempo Imposto	1h 35' 00"
		<b>Soarza</b>	Media Km/h

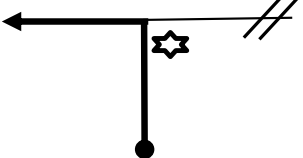
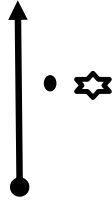
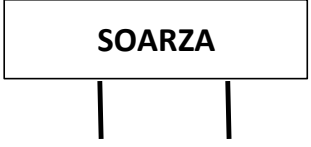
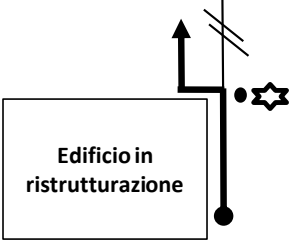
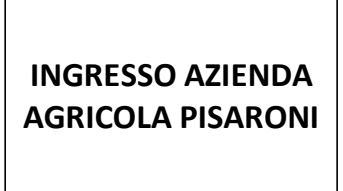
Distanza			INFORMAZIONI	Distanza dal C.O.
Parziale	Totale			
<b>0,620</b>	54,860	115 		<b>3,400</b>
<b>0,070</b>	54,930	116 		<b>3,330</b>
<b>0,200</b>	55,130	117 		<b>3,130</b>
<b>0,230</b>	55,360	118 		<b>2,900</b>
<b>0,720</b>	56,080	119 		<b>2,180</b>
<b>0,200</b>	56,280	120 		<b>1,980</b>

Settore	<b>Piacenza</b>	Distanza Km.	58,260
<b>1</b>		Tempo Imposto	1h 35' 00"
	<b>Soarza</b>	Media Km/h	35,00

Distanza			INFORMAZIONI	Distanza dal C.O.
Parziale	Totale			
<b>1,210</b>	57,490	121 		<b>0,770</b>
<b>0,060</b>	57,550	122 	<b>SOARZA</b> 	<b>0,710</b>
<b>0,600</b>	58,150	123 	<b>INGRESSO AZIENDA AGRICOLA PISARONI</b> 	<b>0,110</b>
<b>0,110</b>	58,260	124 	 	<b>0,000</b>